

SOLCLEAR UV STERILIZER

Operating Instructions Manual

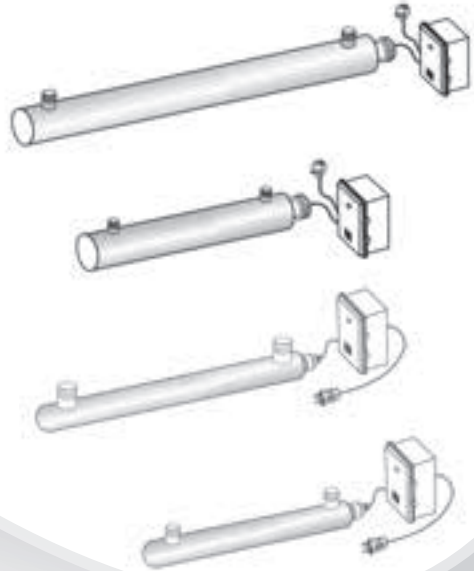

WARNING

This equipment must be installed and serviced by a qualified technician. Improper installation may result in property damage, serious injury or death. Improper installation and/or operation will void the warranty.



Notice to Installer

This manual contains important information about the installation, operation and safe use of this product. Once the product has been installed **this manual must be given to the owner/operator of this equipment.**

SOLCLEAR 45 & 90

Model	Flow Rate		Quartz Thimble Size mm	Inlet & Outlet Size	UV Lamp	Lamp Wattage	Standard Ballasts	Controller Box Size mm
	gpm	lpm						
Solclear 45	12	45.42	D24.5x680	1" BSP	T529	29W	UV-6	190x280
Solclear 90	24	90.85	D24.5x910	1 1/2" BSP	T540	40W	UV-6	190x280

Lamps Life: 9000 hours

Input Voltage : 100-240Vac/50-60Hz

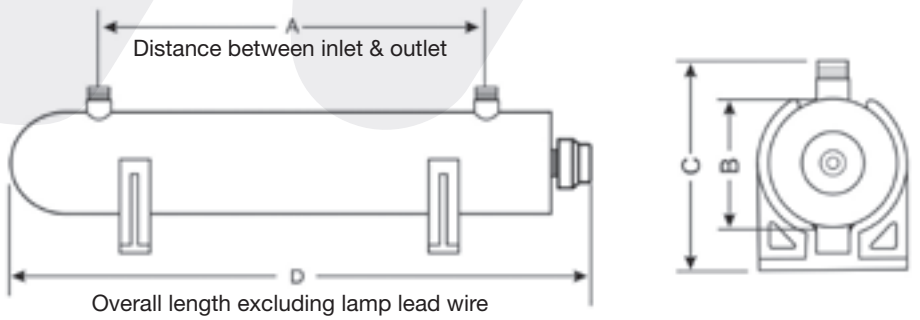

NOTE : Line cord and lamp lead wire omitted for clarity.

Model	A	B	C	D	Inlet & Outlet Size
Solclear 45	585 mm	63.5 mm	108 mm	695 mm	1" BSP
Solclear 90	780 mm	63.5 mm	115 mm	925 mm	1 1/2" BSP

INSTALLATION DIAGRAM

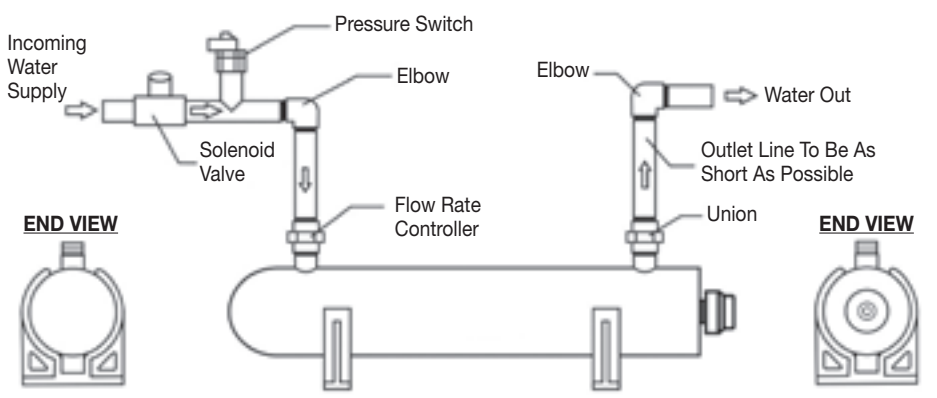

NOTES:

1. Do not allow Solclear UV sterilizer to freeze.
2. Recommended ambient temperature: 2°C-40°C (36°F-104°F).
3. Input voltage is 100-240Vac / 50-60Hz.
4. Maximum recommended operating pressure is 100psi (6.9bar).
5. The system and installation shall comply with applicable state and local regulations.

ASSEMBLY

CAUTION: ULTRAVIOLET LAMP AND QUARTZ SLEEVE ARE EASILY DAMAGED. PAY ATTENTION WHEN REMOVING OR REPLACING LAMP AND QUARTZ SLEEVE.

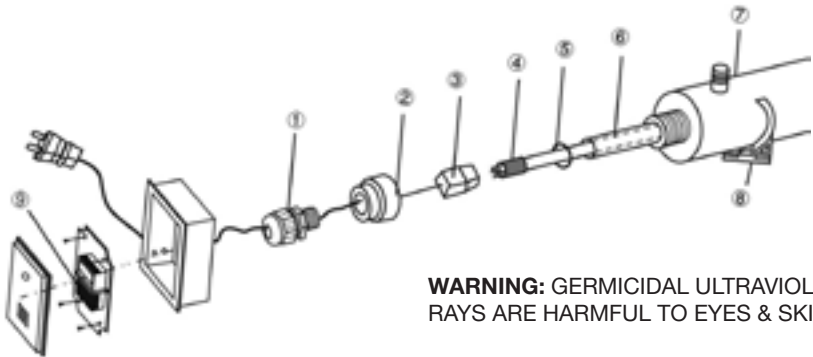

WARNING: GERMICIDAL ULTRAVIOLET RAYS ARE HARMFUL TO EYES & SKIN.

ITEM	DESCRIPTION	Solclear 45 (Part No.)	Solclear 90 (Part No.)
1	Water Proof Strainer	64489	64489
2	Aluminium Nut	725110641	725110641
3	Lamp Socket & Lead Wire	725110511	725110511
4	Germicidal Ultraviolet Lamp	725110422	725110423
5	O-ring BS212 Silicone	725912120	725912120
6	Quartz Sleeve	725110412	725110413
7	Stainless Steel Chamber	-	-
8	Plastic Clip	725120041	725120041
9	Ballast	725120052	725120052

SOLCLEAR 100 & 150

Model	Flow Rate		Quartz Thimble Size mm	Inlet & Outlet Size	UV Lamp	Lamp Wattage	Standard Ballasts	Controller Box Size mm
	gpm	lpm						
Solclear 100	27	100	D24.5x400	1 1/2" BSP	T516	16W	UV-3	125x175
Solclear 150	40	150	D24.5x910	1 1/2" BSP	T540	40W	UV-6	190x280

Lamps Life: 9000 hours

Input Voltage : 100-240Vac/50-60Hz

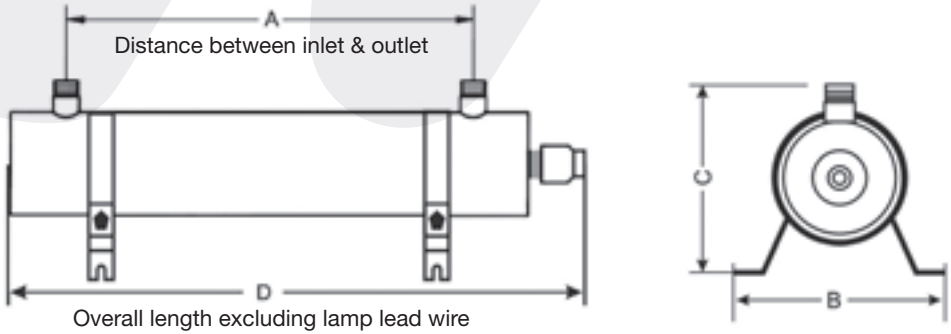

NOTE : Line cord and lamp lead wire omitted for clarity.

Model	A	B	C	D	Inlet & Outlet Size
Solclear 100	276 mm	165 mm	165 mm	414 mm	1 1/2" BSP
Solclear 150	786 mm	175 mm	165 mm	926 mm	1 1/2" BSP

INSTALLATION DIAGRAM

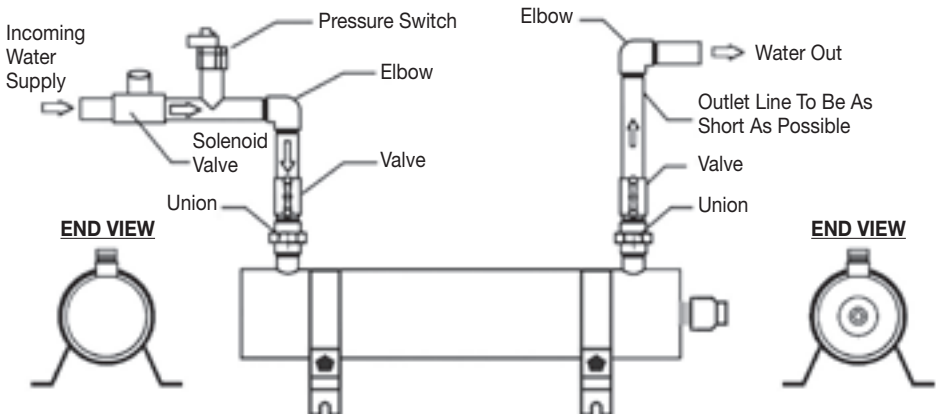

NOTES:

1. Install the Solclear UV sterilizer on an accessible and well-lit location to facilitate inspection and maintenance.
2. Do not allow Solclear UV sterilizer to freeze.
3. Recommended ambient temperature: 2°C-40°C (36°F-104°F).
4. Input voltage is 100-240Vac / 50-60Hz.
5. Maximum recommended operating pressure is 100psi (6.9bar).

ASSEMBLY

CAUTION: ULTRAVIOLET LAMP AND QUARTZ SLEEVE ARE EASILY DAMAGED. PAY ATTENTION WHEN REMOVING OR REPLACING LAMP AND QUARTZ SLEEVE.

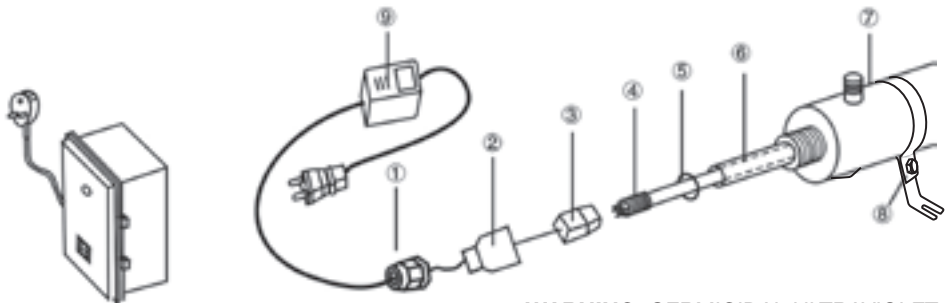

WARNING: GERMICIDAL ULTRAVIOLET RAYS ARE HARMFUL TO EYES & SKIN.

ITEM	DESCRIPTION	Solclear 100 (Part No.)	Solclear 150 (Part No.)
1	Water Proof Strainer	64489	64489
2	Aluminium Nut	725110641	725110641
3	Lamp Socket & Lead Wire	725110511	725110511
4	Germicidal Ultraviolet Lamp	725110421	725110423
5	O-ring BS212 Silicone	725912120	725912120
6	Quartz Sleeve	725110411	725110413
7	Stainless Steel Chamber	-	-
8	Metal Clip	725120042	725120042
9	Ballast	725120051	725120052

INSTALLATION :

1. Install Solclear UV sterilizer in a readily accessible and well-lit location to facilitate inspection and maintenance.
2. Inspect for hidden electrical wiring or plumbing prior to drilling holes.
3. Attach mounting clips to the wall.
4. Insert chamber through mounting clips.
5. Connect to plumbing.
6. Install quartz sleeve and lamp.

Note: Avoid touching the sides of the quartz sleeve and lamp, handle by the ends only. Ultraviolet lamp and quartz sleeve are easily damaged. Pay attention when removing or replacing lamp and quartz sleeve.

- a. Remove the aluminium nut (2).
 - b. Slide carefully the quartz sleeve (6) from one end to another end of the chamber.
 - c. Slide the O-ring (5) on the open end of quartz sleeve.
 - d. Tighten the aluminium nut (2) hand tight.
 - e. Slide the lamp (4) into the quartz sleeve.
 - f. Connect the lamp to the lamp socket.
 - g. Tighten the water proof strainer (1) into the aluminium nut (2).
7. Turn on the water and inspect for leakages. Rectify as necessary.
 8. Plug the ballast into an electrical outlet. An electrical outlet protected by a Ground Fault Interrupt (GFI) circuit is recommended.
 9. Run water through the chamber for 5-10 minutes prior to use.

REPLACING UV LAMP AND SERVICING UV SYSTEM:

NOTE : Avoid touching the sides of the quartz sleeve and lamp, handle by the ends only.

1. Disconnect power.
2. Turn water off and open down stream of system to relieve pressure.
3. Remove the water proof strainer (1) and unscrew the aluminium nut (2).
4. Carefully withdraw lamp (4) approximately 2 inches from chamber (7).
5. While holding lamp end carefully, remove lamp socket (3).
6. Carefully withdraw lamp from chamber (7).
7. Carefully remove O-ring (5) from the end of the quartz sleeve (6).
8. Carefully remove the quartz sleeve (6).
9. To reinstall, follow step 8 through 1 in reverse.

MAINTENANCE

To operate the Solclear UV sterilizer properly and attain its maximum efficiency, appropriate maintenance is to be performed as follows:

- I. Quartz sleeve cleaning or replacement:
 - Quartz sleeve is to be cleaned every 6-12 months with glass cleaner.
 - Quartz sleeve is to be replaced every 24 months.
- II. UV lamp replacement is recommended every 8,000 - 9,000 hours of operation (Approximately 12 months of continuous service).

OFFICES - AUSTRALIA

NSW - SYDNEY
(HEAD OFFICE)
Tel: +61 2 9898 8600

QLD - BRISBANE
Tel: +61 7 3299 9900

VIC/TAS - MELBOURNE
Tel: +61 3 9764 1211

WA - PERTH
Tel: +61 8 9273 1900

SA/NT - ADELAIDE
Tel: +61 8 8244 6000

ACT DISTRIBUTION
Tel: +61 2 6280 6476

OFFICES - OVERSEAS

WATERCO (EUROPE) LIMITED
Sittingbourne, Kent, UK
Tel: +44 (0) 1795 521 733

WATERCO FRANCE
Saint Priest, France
Tel: +33 4 72 79 33 30

WATERCO (USA) INC
Augusta, Georgia, USA
Tel: +1 706 793 7291

WATERCO CANADA
Longueuil, Quebec, Canada
Tel: +1 450 748 1421

WATERCO (NZ) LIMITED
Auckland, New Zealand
Tel: +64 9 525 7570

WATERCO © LIMITED
Guangzhou, China
Tel: +86 20 3222 2180

WATERCO (FAR EAST) SDN BHD
Selangor, Malaysia
Tel: +60 3 6145 6000

PT WATERCO INDONESIA
Jakarta, Indonesia
Tel: +62 21 4585 1481

WATERCO SINGAPORE INTL PTE LTD
Nehsons Building, Singapore
Tel: +65 6344 2378