

**WATERCO**

water, the liquid of life

[www.watercocentral.com](http://www.watercocentral.com)

# COMMERCIAL PUMPS



# Commercial Pumps

Waterco commercial pumps are high performance corrosion resistant thermoplastic pumps, purpose built for commercial swimming pools, aquatic facilities and water parks.

Waterco's pump's unique construction offers several advantages in comparison to steel pumps. Glass reinforced thermoplastic possesses superior mechanical and chemical resistance compared to steel.

The pump body does not rust or corrode and able to withstand damage from many types of water treatment chemicals. Waterco's thermoplastic pumps' weighs less than its steel counterparts without any sacrifice in strength and durability. Their weight makes them easier to ship to the job site and easier to install.



# Hydrostar MKIV

The Hydrostar MKIV has been designed to provide a substantially quieter operation with even higher flow rates and higher head than the previous Hydrostar models. Waterco has optimised the pump's hydraulic efficiency by reshaping its internal profile.



- 3" half union connections.
- Large 6L hair and lint pot.
- Clear pump lid for easy inspection of the strainer basket.
- Quarter turn lid and lock ring with easy grip handles
- High grade Mechanical Seal - Carbon / Graphite with 316 stainless steel.
- Heavy duty IP55 weather proofed motor with SS431 stainless steel shaft.
- Hydraulically efficient internal volute.
- Drain plugs.
- Integral support base for ease of mounting.
- Pump Body - UV stabilised glass filled thermoplastic.

## Performance Chart

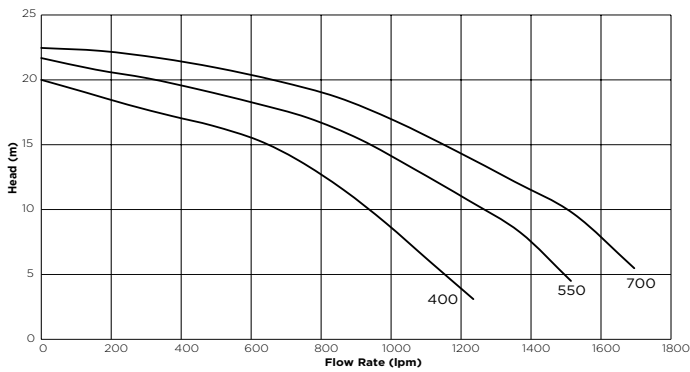

## Sound Levels

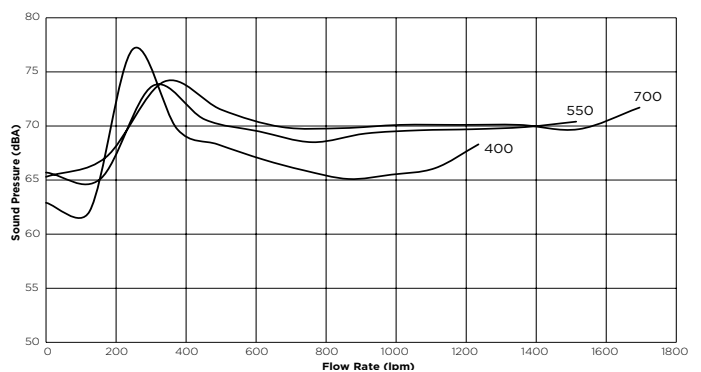

## Technical Specifications

Pump Code	Model	Pump Input Power		Amps/Phase	Weight (kg)	Total Length (mm)	Motor Frame	Motor input (kW)	RPM
		(kW)	(HP)						
2404400333	400 MK4 IE3	3.0	4	5.8	41	846	100	3.4	2890
2404550333	550 MK4 IE3	4.3	5.7	8.1	50	867	112	5.0	2930
2404700333	700 MK4 IE3	5.4	7.2	10.3	54	929	112	6.2	2917

Phase	Volts	Cycle	Motor IP Rating	Pump Rating
3	380-415	50	55	X5

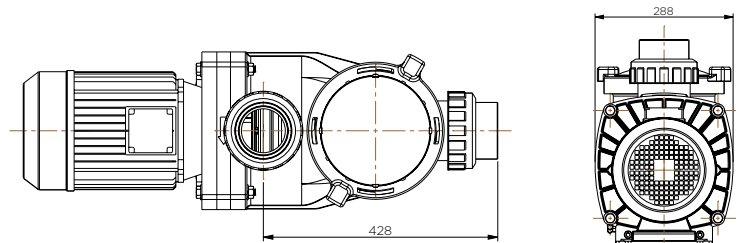
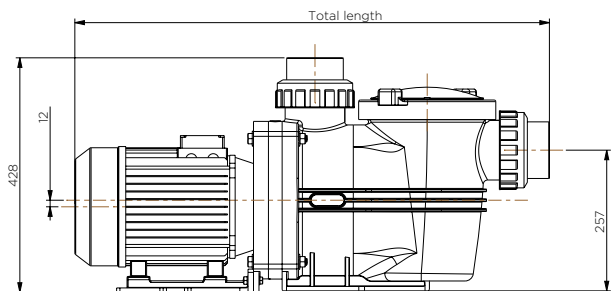

## Material

- Motor Bracket : GF Polypropylene
- Pump Bracket : GF Polypropylene
- Pump Body O Ring : NBR
- Seal Assembly : Alumina Ceramic/SS316/  
Carbon (Silicon Carbide optional)
- Impeller : GF Noryl

# Hydrostar Plus

Hydrostar Plus pumps are high performance corrosion resistant thermoplastic pumps equipped with 6" flanged inlet port & 4" flanged outlet port, purpose built for aquatic facilities, water parks and large commercial swimming pools.

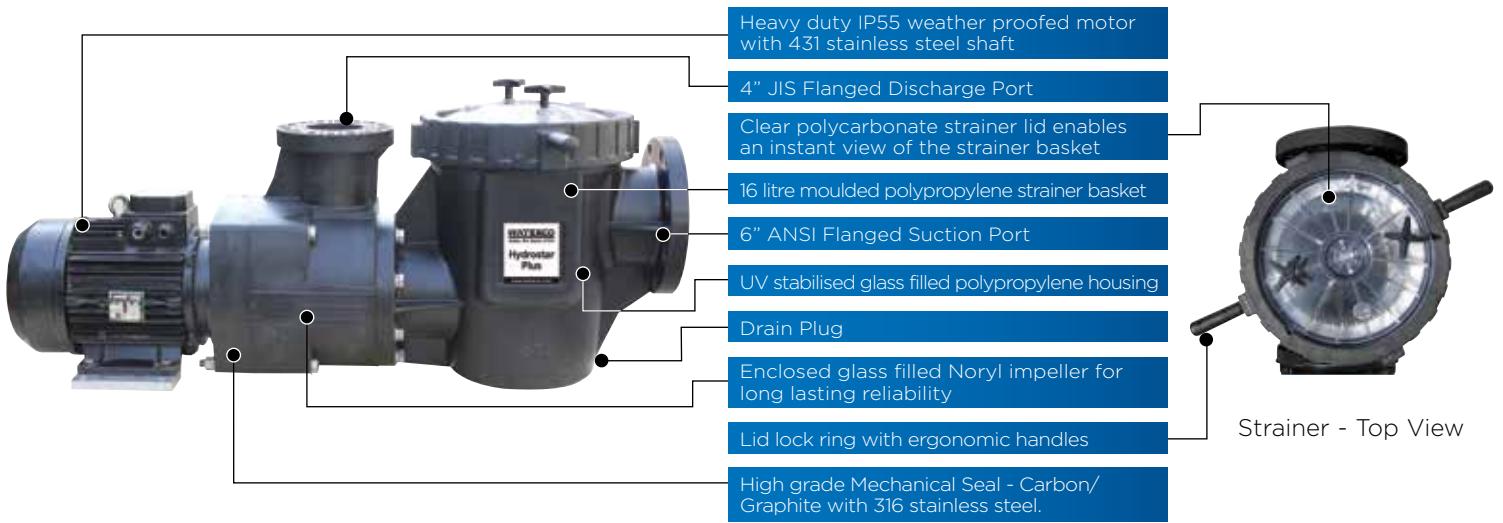

## Performance Chart

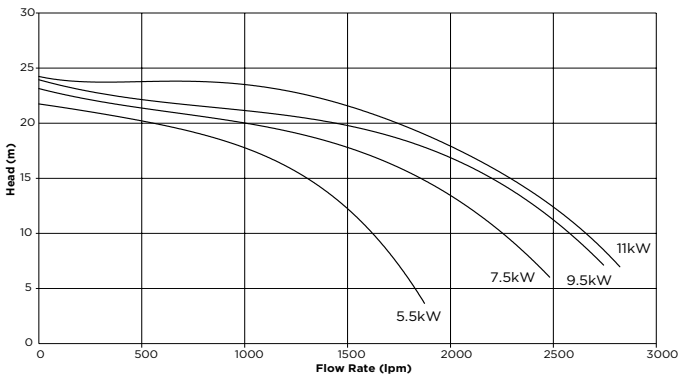

## Sound Levels

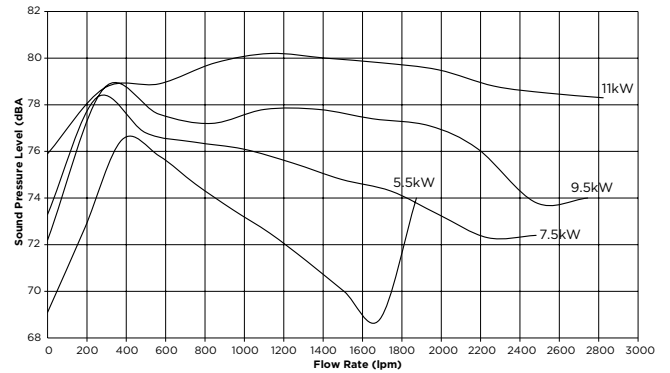

## Technical Specifications

Pump Code	Model	Motor Input (kW)	Nominal Power (HP)	Amps	Phases	Volts	Weight (kg)	Total Length (mm)	Motor Frame	Pump Rating	Motor
2460750	5.5kW	5.8	7.8	10.4	3	380 - 415	73	1190	132	IPX5	2930
2461000	7.5kW	8.3	11.1	14.6	3	380 - 415	75	1190	132	IPX5	2940
2461250	9.5kW	9.9	13.3	17.7	3	380 - 415	91	1218	132	IPX5	2960
2461500	11kW	11.4	15.3	20.3	3	380 - 415	92	1218	132	IPX5	2940

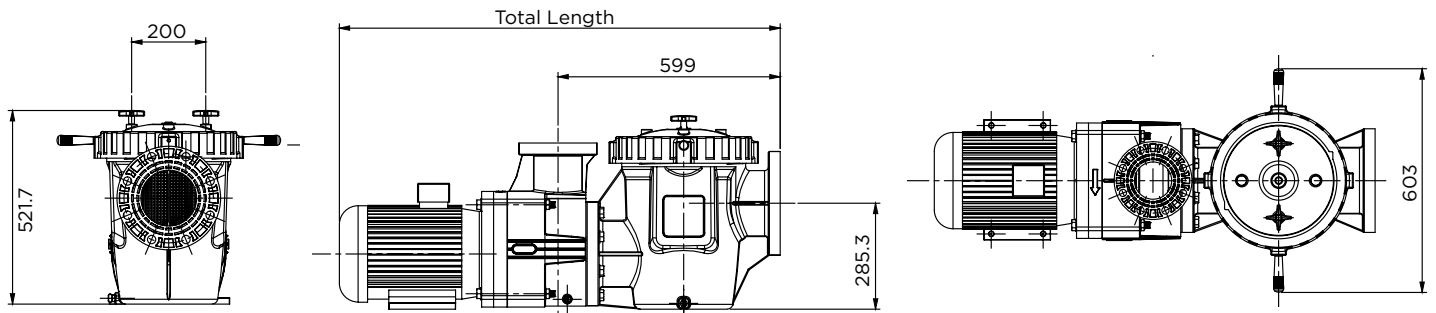

- Diffuser : GF Polypropylene
- Pump Body : GF Polypropylene
- Strainer Basket : Polypropylene
- Strainer Lid : Polycarbonate
- Lock Ring : GF Noryl

### Commercial Pumps Warranty - Commercial Applications

Conditions	Warranty Period
Wet Ends	2 years
Hair & lint pot lid, o'ring, basket, impeller & diffuser	2 years
Motor and mechanical seal	1 year

For detailed terms and conditions please refer to Waterco's Warranty Booklet.



## Company Profile

Waterco pioneers reliable solutions for healthy, safe water environments, which are used in residential, commercial and industrial applications in over 40 countries.

Established in 1981 in Sydney, Australia, it has since become a global brand recognised for designing and manufacturing filtration and sanitisation innovations for the swimming pool, spa, aquaculture, and water purification sectors.



### OFFICES - AUSTRALIA

NSW - Sydney (Head Office)

Tel: +61 2 9898 8600

QLD - Brisbane

Tel: +61 7 3299 9900

VIC/TAS - Melbourne

Tel: +61 3 9764 1211

WA - Perth

Tel: +61 8 9273 1900

SA/NT - Adelaide

Tel: +61 8 8244 6000

ACT Distribution

Tel: +61 2 6280 6476

### OFFICES - OVERSEAS

Waterco (Europe) Limited

Sittingbourne, Kent, UK

Tel: +44 (0) 1795 521 733

Waterco (USA) Inc

Augusta, Georgia, USA

Tel: +1 706 793 7291

Waterco Canada

Boucherville, Quebec, Canada

Tel: +1 450 748 1421

Waterco (NZ) Limited

Auckland, New Zealand

Tel: +64 9 525 7570

Waterco (C) Limited

Guangzhou, China

Tel: +86 20 3222 2180

Waterco (Far East) Sdn Bhd

Selangor, Malaysia

Tel: +60 3 6145 6000

PT Waterco Indonesia

Jakarta, Indonesia

Tel: +62 21 4585 1481

Waterco Singapore Intl Pte Ltd

Nehsons Building, Singapore

Tel: +65 6344 2378

**WATERCO**  
water, the liquid of life



In the interest of providing better quality and value we are constantly improving and updating our products. Consequently, pictures and information on our brochures may sometimes vary slightly from models available.